

Assembly Layout/装配方案

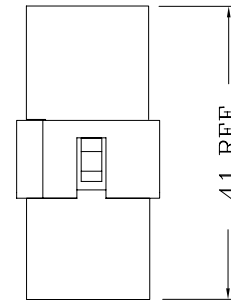
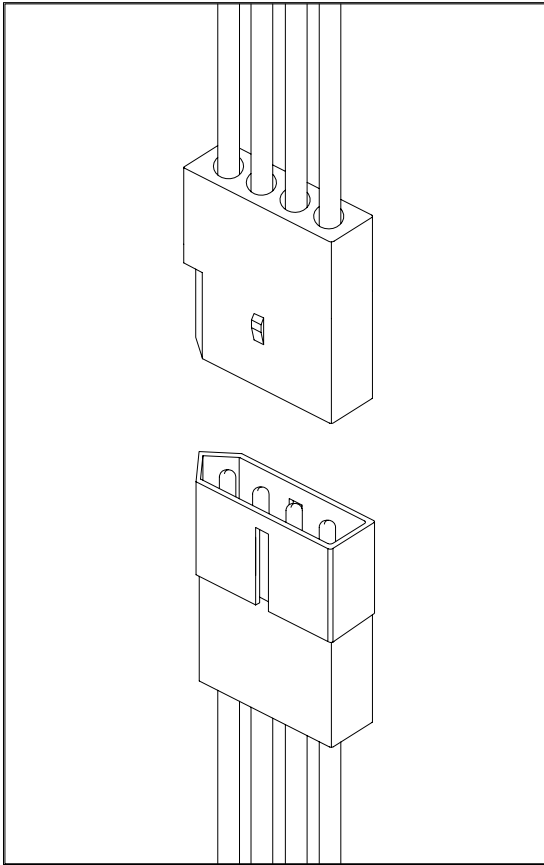

Specifications/技术参数:

Poles/位数	1~15 Poles
Plug Diameter/插头直径	Ø 2.36mm
Rated Voltage/额定电压	600V AC,DC
Rated Current/额定电流	15A (AWG #14)
Withstand Voltage/耐压值	1500V AC/minute
Contact Resistance/接触电阻	10mΩ (MAX.)
Insulation Resistance/绝缘电阻	1000MΩ (MIN.)
Temperature Range/温度范围	-25°C ~ +85°C
Applicable Wire Range/适用线径	AWG #22~#28

2030B SERIES Ø2.36mm Plug Crimp Terminal

Features/产品特性:

* Used in 2030B series socket(用于2030B系列塑壳)

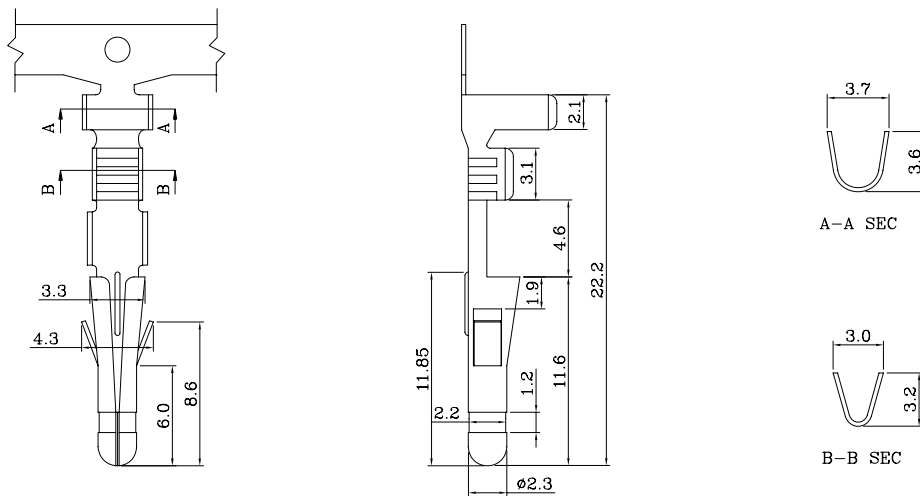

Part No./产品型号	Wire Range/线径范围	Insulation O.D/线外径	Material/材质	Finish/表面处理
2030BT	AWG #22 ~ #28	1.90mm(max)	Brass	Tin-plated

2130B SERIES Ø2.36 Receptacle Crimp Terminal

Features/产品特性:

* Used in 2130B series socket(用于2130B系列塑壳)

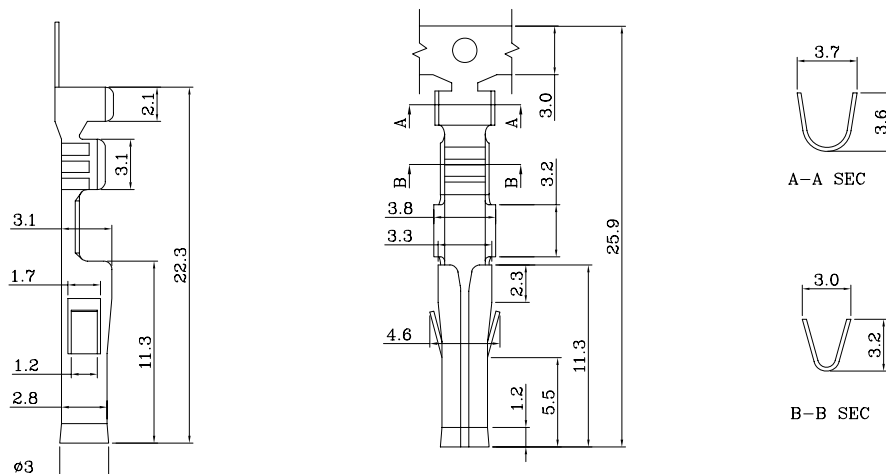

Part No./产品型号	Wire Range/线径范围	Insulation O.D/线外径	Material/材质	Finish/表面处理
2130BT	AWG #22 ~ #28	1.90mm(max)	Brass	Tin-plated

Features/产品特性:

- * Single, Dual & Triple Row Terminal Socket(单排,双排和三排端子塑壳)
- * Material(材质): Nylon 66 UL 94V-2 (Natural)

Specification/产品说明:

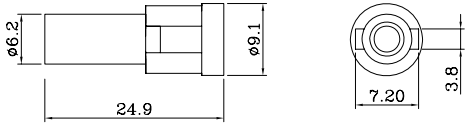
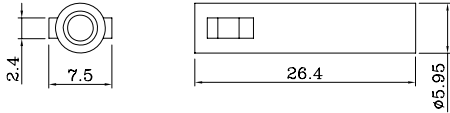
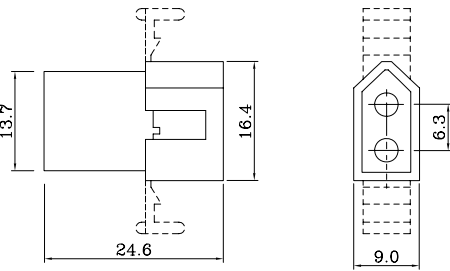
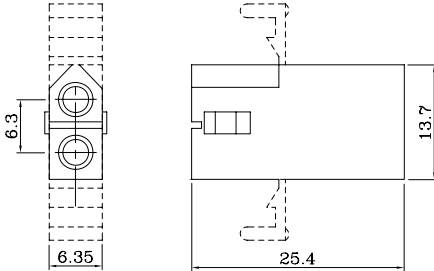
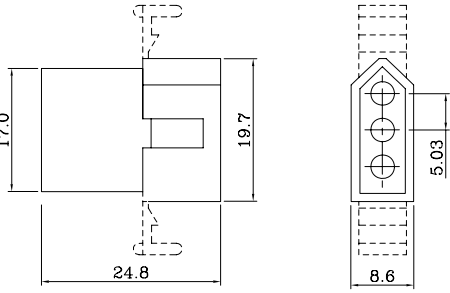
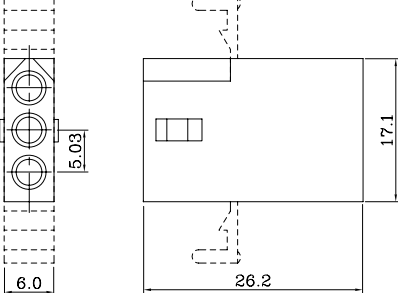
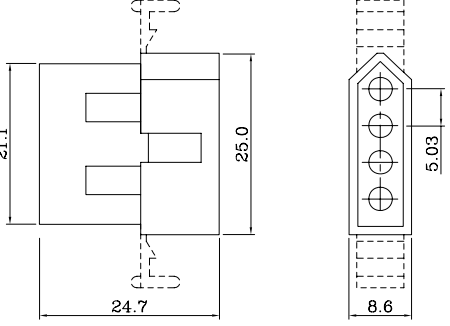
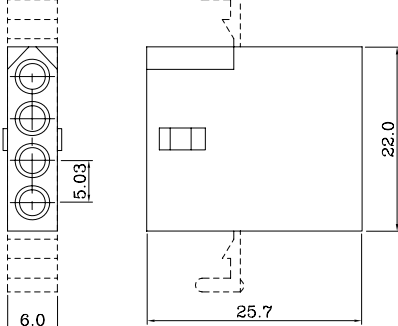
PLUG/插头	RECEPTACLE/插座
 <p style="text-align: center;">2030BH-1*01P</p>	 <p style="text-align: center;">2130BH-1*01P</p>
 <p style="text-align: center;">2030BH-1*02P(K)</p>	 <p style="text-align: center;">2130BH-1*02P(K)</p>
 <p style="text-align: center;">2030BH-1*03P(K)</p>	 <p style="text-align: center;">2130BH-1*03P(K)</p>
 <p style="text-align: center;">2030BH-1*04P(K)</p>	 <p style="text-align: center;">2130BH-1*04P(K)</p>

Specification/产品说明：

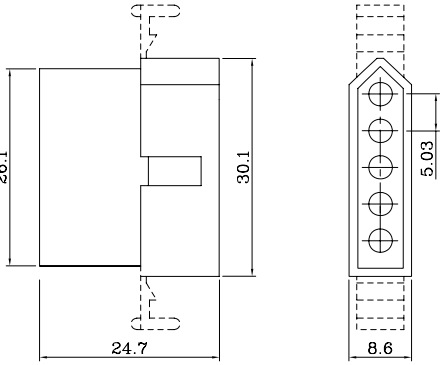
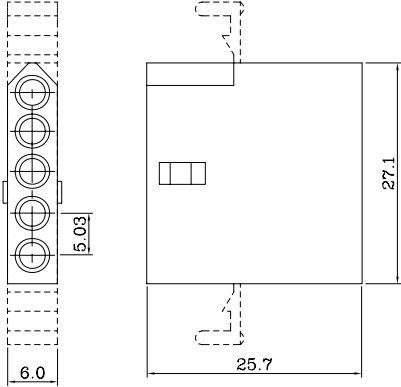
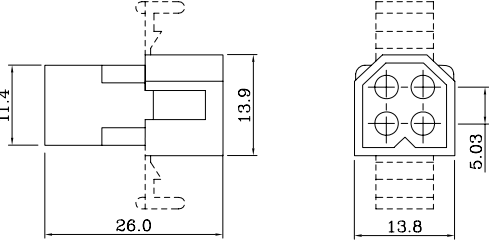
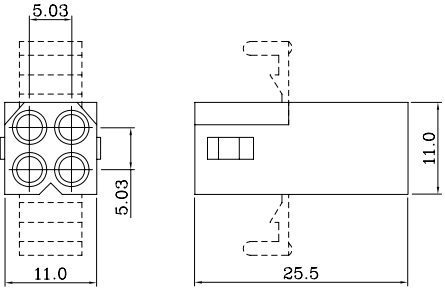
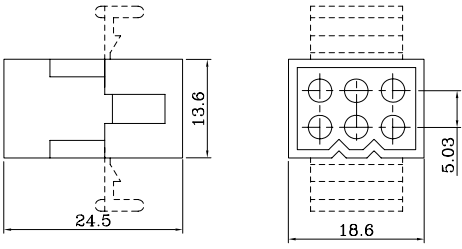
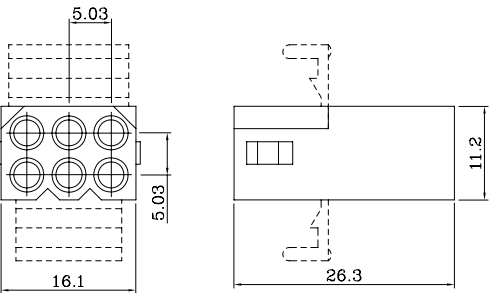
PLUG/插头	RECEPTACLE/插座
 <p data-bbox="411 846 678 884">2030BH-1*05P(K)</p>	 <p data-bbox="1058 846 1321 884">2130BH-1*05P(K)</p>
 <p data-bbox="411 1422 678 1460">2030BH-2*02P(K)</p>	 <p data-bbox="1058 1422 1321 1460">2130BH-2*02P(K)</p>
 <p data-bbox="411 2004 678 2042">2030BH-3*02P(K)</p>	 <p data-bbox="1058 2004 1321 2042">2130BH-3*02P(K)</p>

Specification/产品说明：

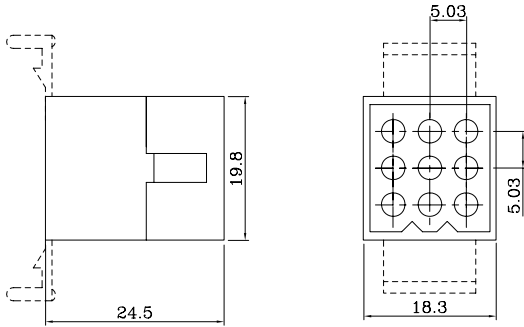
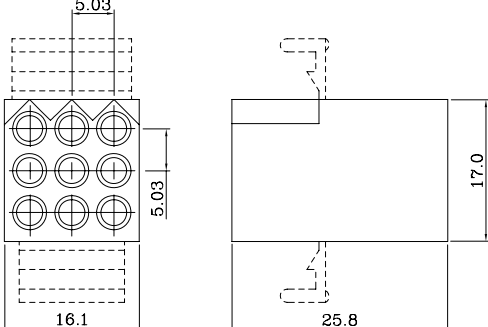
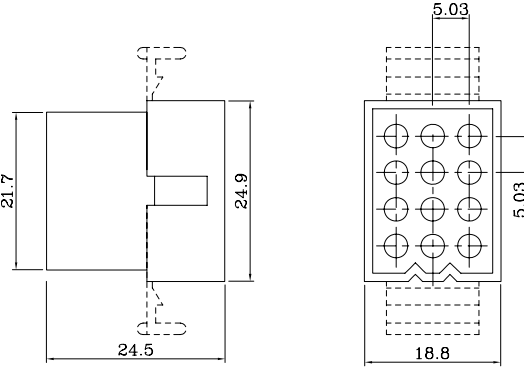
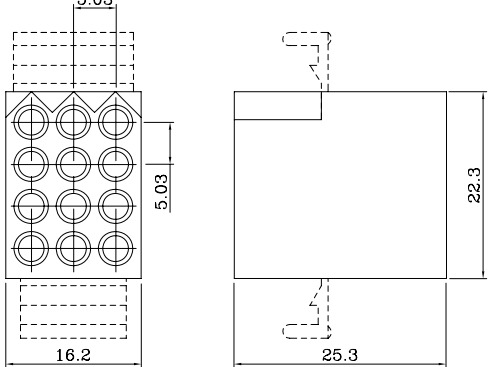
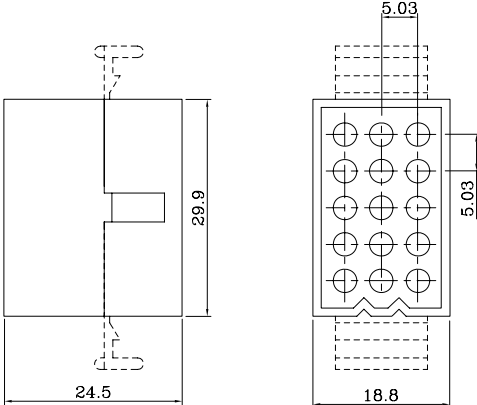
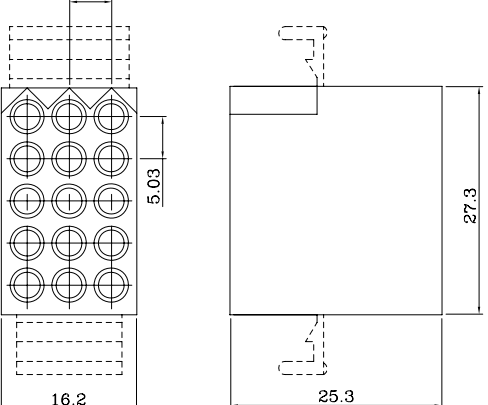
PLUG/插头	RECEPTACLE/插座
 <p data-bbox="411 846 679 882">2030BH-3*03P(K)</p>	 <p data-bbox="1058 846 1326 882">2130BH-3*03P(K)</p>
 <p data-bbox="411 1424 679 1460">2030BH-3*04P(K)</p>	 <p data-bbox="1058 1424 1326 1460">2130BH-3*04P(K)</p>
 <p data-bbox="411 2007 679 2042">2030BH-3*05P(K)</p>	 <p data-bbox="1058 2007 1326 2042">2130BH-3*05P(K)</p>