

DIN41612 SERIES Three Row Connectors

Specifications/技术参数:

Electrical/电气特性:

Current Rating(额定电流): 2A
 Withstand Voltage(耐压值): 1000VAC for one minute
 Contact Resistance(接触电阻): 30mΩ max
 Insulation Resistance(绝缘电阻): 1000MΩ min
 Operating Temperature(工作温度): -55°C ~ +105°C

Physical/物理特性:

Insulator(塑胶本体): P.B.T +30% Glass Fiber
 Flammability Rating(防火等级): UL 94V-0
 Contacts(接触件): Copper Alloy
 Contacts plating(接触件电镀): Gold over Nickel or Tin

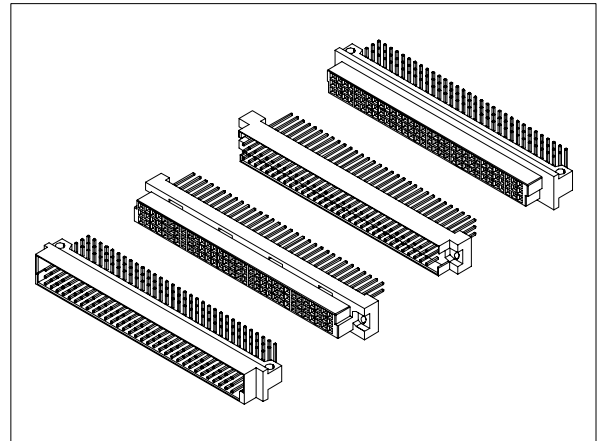



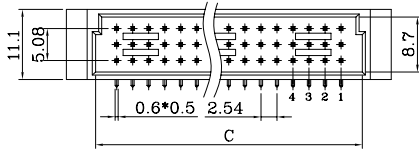
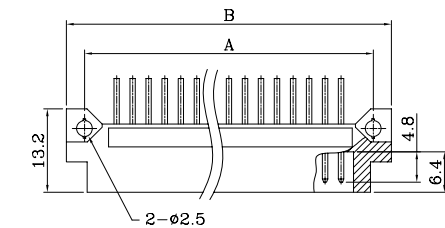



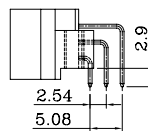
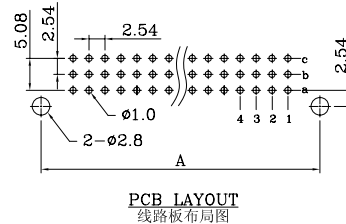

Dimension/尺寸: mm



MR-TYPE
公弯-类型





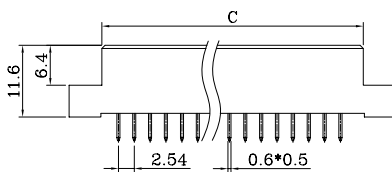
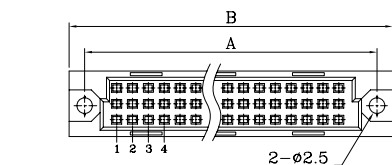



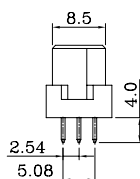
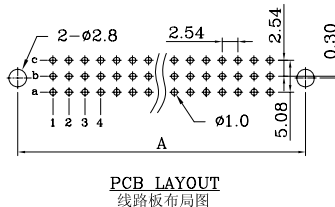

| Poles 位数 | Pin 位数 | Position 位置 | Layout 布局图 | Dimension/尺寸 | | |
|-------------|-----------|----------------|---|--------------|------|------|
| | | | | A | B | C |
| 96 | 96 | abc |  | 88.9 | 94.0 | 85.2 |
| | 64 | ab- |  | | | |
| | 64 | a-c |  | | | |
| 48 | 32 | a-- |  | 48.26 | 54.0 | 44.6 |
| | 48 | abc |  | | | |
| | 32 | ab- |  | | | |
| | 32 | a-c |  | | | |
| 16 | a-- | a-- |  | | | |



FS-TYPE
母直-类型



| Poles 位数 | Pin 位数 | Position 位置 | Layout 布局图 | Dimension/尺寸 | | |
|-------------|-----------|----------------|---|--------------|------|------|
| | | | | A | B | C |
| 96 | 96 | abc |  | 90.0 | 95.0 | 85.0 |
| | 64 | ab- |  | | | |
| | 64 | a-c |  | | | |
| 48 | 32 | a-- |  | 49.36 | 55.0 | 44.4 |
| | 48 | abc |  | | | |
| | 32 | ab- |  | | | |
| | 32 | a-c |  | | | |
| 16 | a-- | a-- |  | | | |



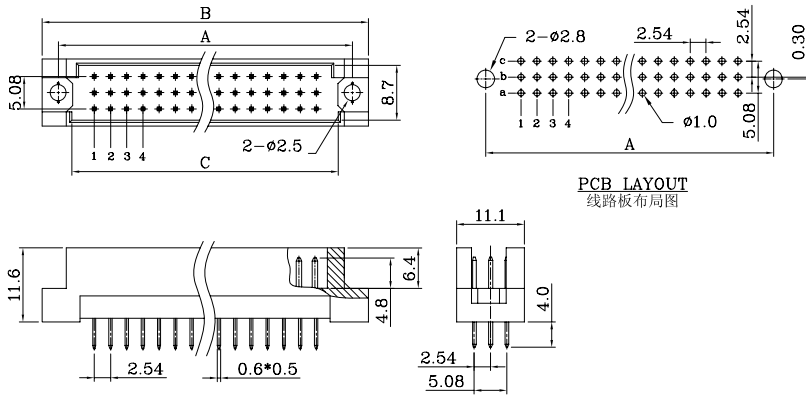



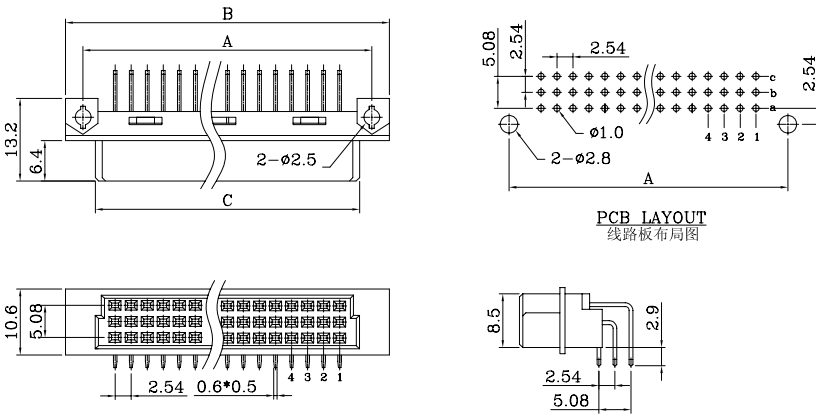

DIN41612 SERIES Three Row Connectors











MS-TYPE
公直-类型



FR-TYPE
母弯-类型

| Poles 位数 | Pin 位数 | Position 位置 | Layout 布局图 | Dimension/尺寸 | | |
|-------------|-----------|----------------|--|--------------|------|------|
| | | | | A | B | C |
| 96 | 96 | abc |  | 90.0 | 95.0 | 85.2 |
| | 64 | ab- |  | | | |
| | 64 | a-c |  | | | |
| | 32 | a-- |  | | | |
| 48 | 48 | abc |  | 49.36 | 55.0 | 44.6 |
| | 32 | ab- |  | | | |
| | 32 | a-c |  | | | |
| | 16 | a-- |  | | | |

| Poles 位数 | Pin 位数 | Position 位置 | Layout 布局图 | Dimension/尺寸 | | |
|-------------|-----------|----------------|---|--------------|------|------|
| | | | | A | B | C |
| 96 | 96 | abc |  | 88.9 | 94.0 | 85.0 |
| | 64 | ab- |  | | | |
| | 64 | a-c |  | | | |
| | 32 | a-- |  | | | |
| 48 | 48 | abc |  | 48.26 | 54.0 | 44.4 |
| | 32 | ab- |  | | | |
| | 32 | a-c |  | | | |
| | 16 | a-- |  | | | |

Ordering Code/订购型号:

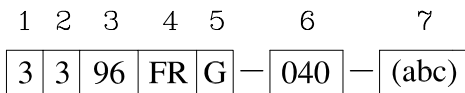

1. Plastic Rows/胶体排数:
3 = 3 Rows
2. Pin Rows/方针排数:
1 = 1 Row
2 = 2 Rows
3 = 3 Rows
3. Total Pins/方针芯数:
16, 32, 48, 64, 96

4. PCB Mount Type/安装类型:
MS = Male-Straight(公直)
MR = Male-Right Angle(公弯)
FS = Female-Straight(母直)
FR = Female-Right Angle(母弯)
5. Contact Plating/接触件电镀:
S = Selective Gold(半金)
G = Gold Flash(全金)

6. Pin Length/焊板针长:
025 = 2.5mm
029 = 2.9mm
040 = 4.0mm
130 = 13.0mm
170 = 17.0mm
7. Contact Layout/方针布局:
(abc), (ab-), (a-b), (a--)