

# 57S SERIES Centronic Connector Solder Type

## Specifications/技术参数:

### Electrical/电气特性:

Current Rating (额定电流): 3A  
 Withstand Voltage (耐压值): 1000VAC for one minute  
 Contact Resistance (接触电阻): 25mΩ max  
 Insulation Resistance (绝缘电阻): 5000MΩ min  
 Operating Temperature (工作温度): -40°C ~ +105°C

### Physical/物理特性:

Insulator (塑胶本体): Glass Filled Polyester  
 Flammability Rating (防火等级): UL 94V-0  
 Contacts (接触件): Copper alloy  
 Contacts plating (接触件电镀): Selective gold plating on surface contact area

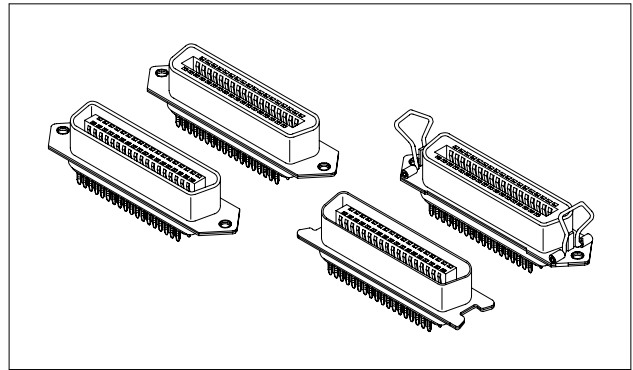

## Dimension/尺寸: mm

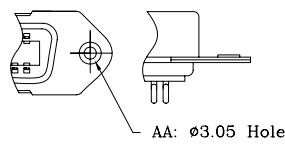
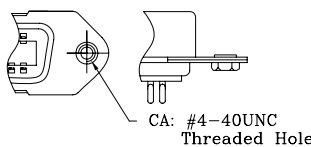
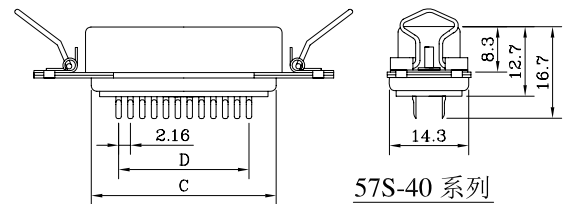
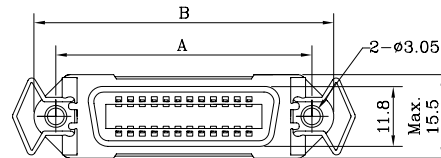
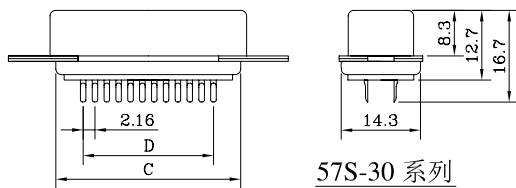
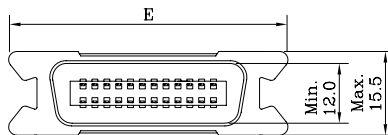
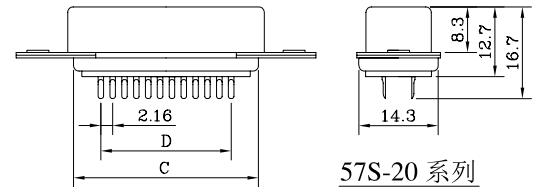
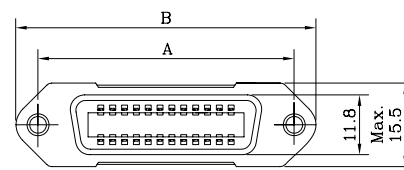
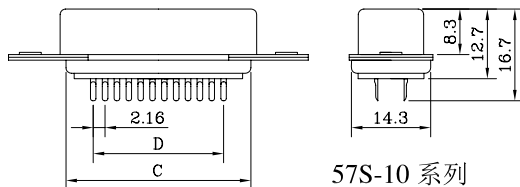
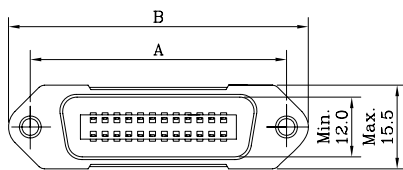

Poles	Dim A	Dim B	Dim C	Dim D	Dim E
14	36.0	43.9	22.9	12.96	37.8
24	46.8	54.7	33.7	23.76	48.6
36	59.7	67.7	46.7	36.72	61.6
50	74.9	82.8	61.8	51.84	76.7

## Ordering Code/订购型号:

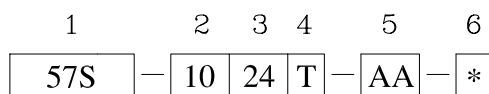

1. Series No./系列号:  
57S

2. Contacts type/接触件类型:  
10, 30 = Male(公头)  
20, 40 = Female(母头)

3. Poles/位数:  
14, 24, 36, 50

4. Port Type/端口类型:  
T = Traditional Type(传统式)  
S = Simple Type(简易式)

5. Mounting options/安装选项:

AA = ø3.05mm Hole(光孔)  
CA = #4-40UNC Threaded Hole(螺纹孔)

6. Insulator color/胶体颜色:  
Default(缺省) = Blue(蓝色)  
3 = Black(黑色)