

Specifications/技术参数:

Electrical/电气特性:

Current Rating (额定电流): 3A
 Withstand Voltage (耐压值): 500VAC for one minute
 Contact Resistance (接触电阻): 20mΩ max
 Insulation Resistance (绝缘电阻): 1000MΩ min
 Operating Temperature (工作温度): -40°C ~ +105°C

Physical/物理特性:

Insulator (塑胶本体): P.B.T +30% Glass Fiber
 Flammability Rating (防火等级): UL 94V-0
 Contacts (接触件): Phosphor Bronze or Brass
 Contacts plating (接触件电镀): Gold flash over Nickel

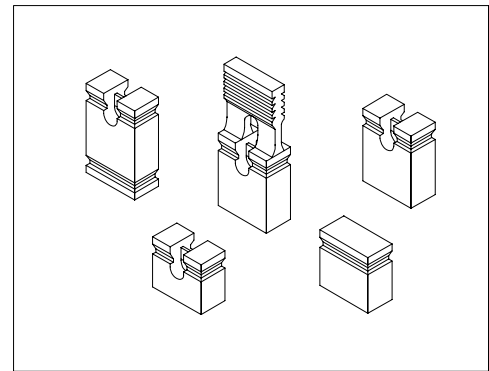

Dimension/尺寸: mm

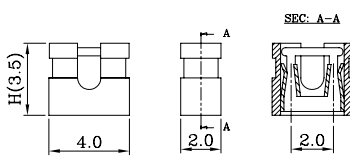
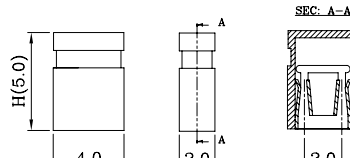
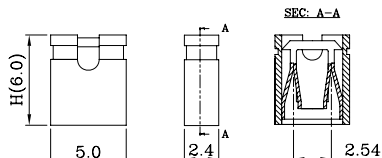
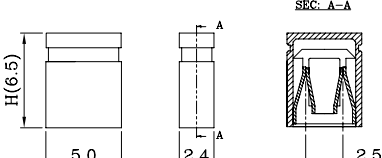
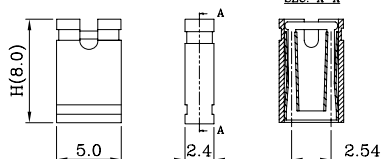
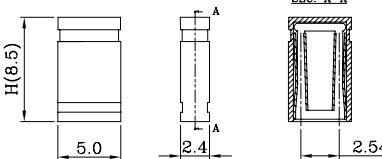
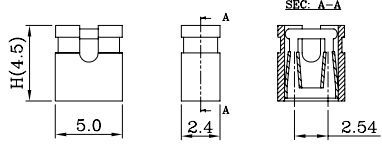
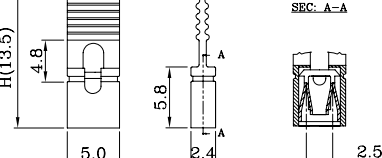
Type-A (开口型) Pitch/间距: 2.00mm	207-2-3.5A	Type-B (闭口型) Pitch/间距: 2.00mm	207-2-5B
			
Type-A (开口型) Pitch/间距: 2.54mm	207-6A	Type-B (闭口型) Pitch/间距: 2.54mm	207-6.5B
			
Type-A (开口型) Pitch/间距: 2.54mm	207-8A	Type-B (闭口型) Pitch/间距: 2.54mm	207-8.5B
			
Type-A (开口型) Pitch/间距: 2.54mm	207-4.5A	Type-B (长柄型) Pitch/间距: 2.54mm	207-13.5C
			

Ordering Code/订购型号:

1 2 3 4 5
 207 - 6 B - P - 1

1. Series No./系列号:

207 = 2.54mm Pitch
 207-2 = 2.00mm Pitch

2. Dimension/尺寸: H

3. Type/类型:

A = Openned Cover(开口型)
 B = Closed Cover(闭口型)
 C = With Handgrip(带手柄)

4. Contacts/接触件:

P = Phosphor Bronze(磷青铜)
 N/A = Brass(黄铜)

5. Color/胶体颜色:

1 = White(白) 2 = Blue(蓝)
 4 = Green(绿) 5 = Red(红)
 6 = Yellow(黄) N/A(缺省) = Black(黑)