

# 301-2 SERIES 2.00mm Fully Shrouded Polarized Headers

## Specifications/技术参数:

### Electrical/电气特性:

Current Rating (额定电流): 1A  
 Withstand Voltage (耐压值): 500VAC for one minute  
 Contact Resistance (接触电阻): 30mΩ max  
 Insulation Resistance (绝缘电阻): 1000MΩ min  
 Operating Temperature (工作温度): -55°C ~ +105°C

### Physical/物理特性:

Insulator (塑胶本体): P.B.T +30% Glass Fiber  
 Flammability Rating (防火等级): UL 94V-0  
 Contacts (接触件): Phosphor Bronze or Brass  
 Contacts plating (接触件电镀): Gold over Nickel or Tin

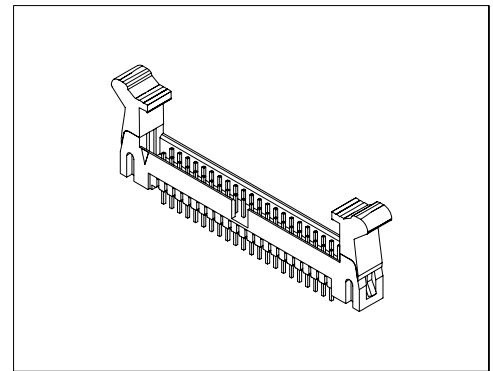

## Dimension/尺寸: mm

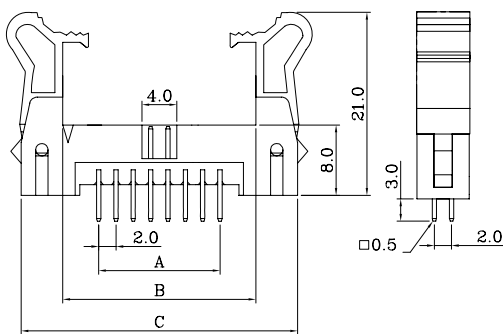
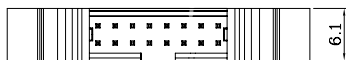

Straight/直插

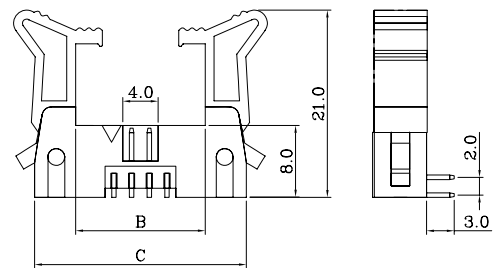
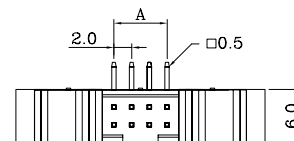

Right Angle/弯插

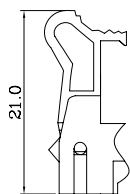

Long Latch/长耳

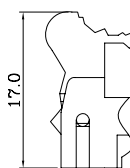

Short Latch/短耳

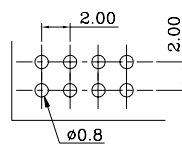

PCB Layout  
线路板布局图

Poles	Dim A	Dim B	Dim C
6	4.0	12.3	21.9
8	6.0	14.3	23.9
10	8.0	16.3	25.9
12	10.0	18.3	27.9
14	12.0	20.3	29.9
16	14.0	22.3	31.9
20	18.0	26.3	35.9
24	22.0	30.3	39.9
26	24.0	32.3	41.9
30	28.0	36.3	45.9
34	32.0	40.3	49.9
40	38.0	46.3	55.9
44	42.0	50.3	59.9
50	48.0	56.3	65.9
60	58.0	66.3	75.9
64	62.0	70.3	79.9

## Ordering Code/订购型号:

1 2 3 4 5 6  
 301-2 S - 20P S B - 4

1. Series No./系列号: 301-2

2. PCB Mount Type/安装类型:

S = Straight DIP Type(直插)

R = Right Angle DIP Type(弯插)

3. Poles/位数: 06~64P

4. Contacts plating/接触件电镀:

N/A(缺省) = Gold Flash(全金)

S = Selective Gold(半金)

5. Latch Option/锁扣选项:

B = Short Latch(短耳)

N/A(缺省) = Long Latch(长耳)

6. Color/胶体颜色:

N/A(缺省) = Black(黑色)

4 = Grey(灰色)