

Specifications/技术参数:

Electrical/电气特性:

Current Rating (额定电流): 1A
 Withstand Voltage (耐压值): 500VAC for one minute
 Contact Resistance (接触电阻): 30mΩ max
 Insulation Resistance (绝缘电阻): 1000MΩ min
 Operating Temperature (工作温度): -55°C ~ +105°C

Physical/物理特性:

Insulator (塑胶本体): P.B.T +30% Glass Fiber
 Flammability Rating (防火等级): UL 94V-0
 Contacts (接触件): Phosphor Bronze or Brass
 Contacts plating (接触件电镀): Gold over Nickel or Tin

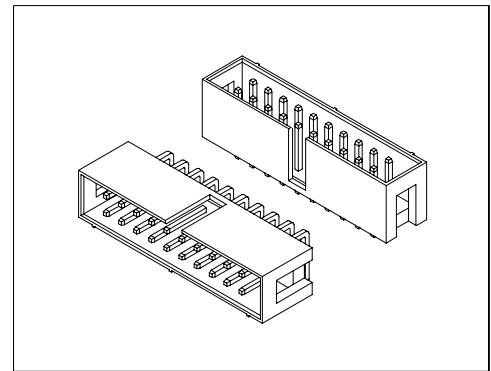

Dimension/尺寸: mm

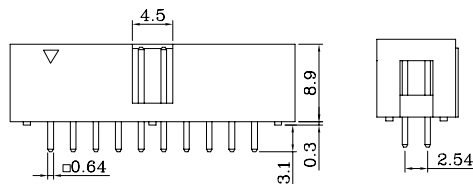
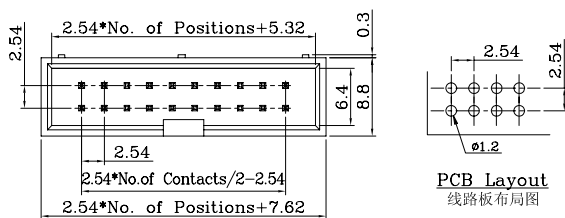

Straight/直插

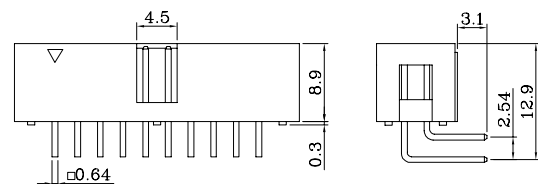
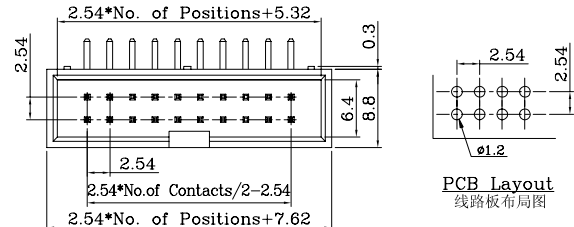

Right Angle/弯插

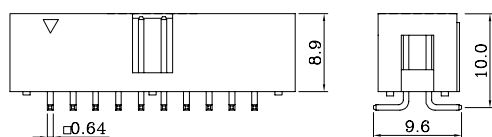
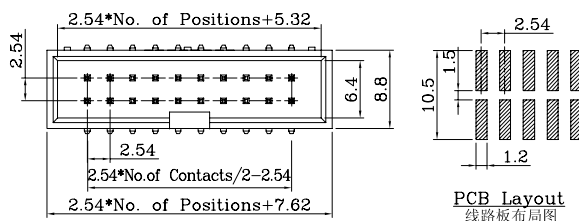

Vertical SMT/立贴

Ordering Code/订购型号:

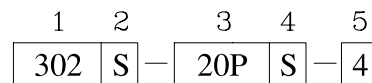

1. Series No./系列号: 302
2. PCB Mount Type/安装类型:
 S = Straight DIP Type(直插)
 R = Right Angle DIP Type(弯插)
 SMS = Vertical SMT Type(立贴)
3. Poles/位数:
 DIP Type: 6P, 8P, 10P, 14P, 16P, 20P, 24P, 26P, 30P, 34P, 40P, 44P, 50P, 60P, 64P
 SMT Type: 6P, 8P, 10P, 14P, 16P, 20P, 24P, 26P, 30P, 34P, 40P
4. Contacts plating/接触件电镀:
 N/A(缺省) = Gold Flash(全金)
 S = Selective Gold(半金)
5. Color/胶体颜色:
 N/A(缺省) = Black(黑色)
 4 = Grey(灰色)